

Operating Instruction for AC TRMS CLAMP METER





Please read this manual before switching the unit on.
Important safety information inside.

| Content | Page |
|--|-------------|
| 1.Safety..... | 4 |
| 2.Description..... | 6 |
| 2-1.Meter Description..... | 6 |
| 2-2.Symbols Used on LCD Display..... | 7 |
| 3.Specifications..... | 8 |
| 3-1.Specifications..... | 8 |
| 3-2.General Specifications..... | 9 |
| 4.Operation..... | 10 |
| 4-1.AC Current Measurements..... | 10 |
| 4-2.DC/AC Voltage Measurements..... | 11 |
| 4-3.Resistance Measurements..... | 11 |
| 4-4.Diode and Continuity Measurements..... | 11 |
| 4-5.Capacitance Measurements..... | 12 |
| 4-6.Temperature Measurements..... | 12 |
| 4-7.Non-Contact AC Voltage Measurements..... | 12 |
| 4-8.Auto Power Off..... | 13 |
| 4-9.Low Battery Indication..... | 13 |
| 5.Button..... | 13 |
| 5-1.MODE and REL Button..... | 13 |
| 5-2.Data Hold Button..... | 13 |
| 5-3.RANGE Button..... | 13 |
| 5-4.MAX/MIN Button..... | 14 |
| 6.Battery Replacement..... | 14 |

1.Safety

International Safety Symbols

-  This symbol, adjacent to another symbol or terminal, indicates the user must refer to the manual for further information.
-  This symbol, adjacent to a terminal, indicates that, under normal use, hazardous voltages may be present
-  Double insulation

SAFETY NOTES

- Do not exceed the maximum allowable input range of any function
- Do not apply voltage to meter when resistance function is selected.
- Set the function switch OFF when the meter is not in use.

WARNINGS

- Set function switch to the appropriate position before measuring.
- When measuring volts do not switch to current/resistance modes.
- When changing ranges using the selector switch always disconnect the test leads from the circuit under test.
- Do not exceed the maximum rated input limits.

CAUTIONS

- Improper use of this meter can cause damage, shock, injury or death. Read and understand this user manual before operating the meter.
- Always remove the test leads before replacing the battery.
- Inspect the condition of the test leads and the meter itself for any damage before operating the meter. Repair or replace any damage before use.
- Use great care when making measurements if the voltages are greater than 25VAC rms or 35VDC. These voltages are considered a shock hazard.
- Remove the battery if the meter is to be stored for long periods.
- Always discharge capacitors and remove power from the device under test before performing Diode, Resistance or Continuity tests.
- Voltage checks on electrical outlets can be difficult and misleading because of the uncertainty of connection to the recessed electrical contacts. Other means should be used to ensure that the terminals are not "live".

- If the equipment is used in a manner not specified by the manufacturer, the protection provided by the equipment may be impaired.

Input Limits

| Function | Maximum Input |
|---|---------------|
| A AC | 400A |
| V AC/DC | 600V DC/AC |
| Frequency | 600V DC/AC |
| Resistance, Diode, Continuity, Capacitance Test, Temperature | 250V DC/ AC |

2. Description

2-1. Meter Description

- | | |
|--|--------------------------------|
| 1-Current Clamp | 7-MODE and Relative Button |
| 2-Non-Contact AC Voltage Indicator Light | 8-MIN/MAX Button |
| 3-Clamp Trigger | 9-RANGE Button |
| 4-Rotary Function Switch | 10-COM Input Jack |
| 5-LCD Display | 11-V Ω CAP TEMP Hz Jack |
| 6-Data Hold Button | 12-Battery Cover |

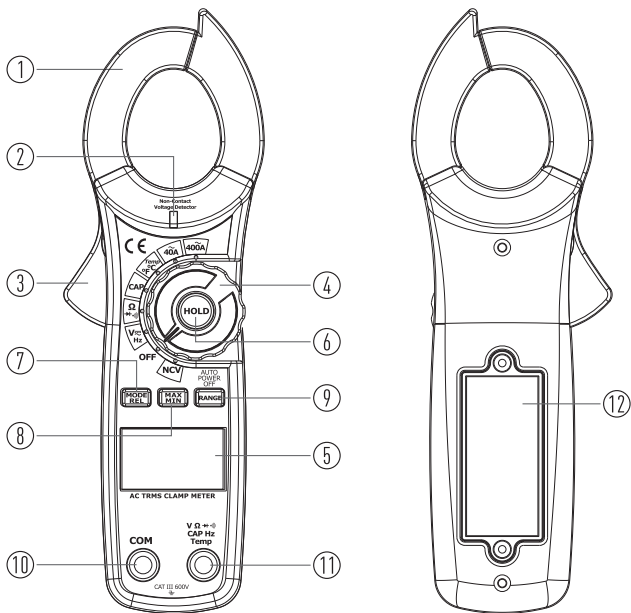

2-2. Symbols Used on LCD Display

- 1-DC (Direct Current)
- 2-AC (Alternating Current)
- 3-Minus Sign
- 4-Auto Power Off
- 5-Auto Range Mode
- 6-Diode Test Mode
- 7-Audible Continuity
- 8-Data Hold Mode
- 9-Relative Mode
- 10-Max Reading
- 11-Min Reading
- 12-Units of Measure List
- 13-Low Battery
- 14-4000 Count (0 to 3999) Measurement Reading

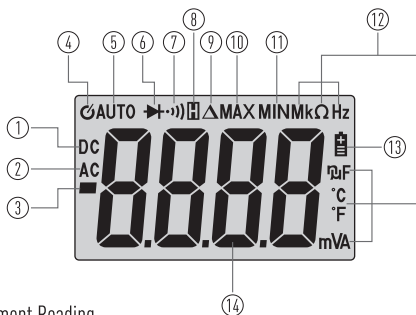

3.Specifications

3-1.Specifications

| Function | Range & Resolution | Accuracy \pm (% of reading) |
|-------------------------|--------------------|-------------------------------|
| AC Current (50/60Hz) | 40.00 AAC | \pm (2.5% + 8 digits) |
| | 400.0 AAC | \pm (2.8% + 5 digits) |

All AC Current ranges are specified from 5% of range to 100% of range.

| | | |
|------------|------------|-------------------------|
| DC Voltage | 400.0 mVDC | \pm (0.5% + 8 digits) |
| | 4.000 VDC | |
| | 40.00 VDC | |
| | 400.0 VDC | |
| | 600.0 VDC | |

| | | |
|---------------------------|-----------|-------------------------|
| AC Voltage (50-1000Hz) | 4.000 VAC | \pm (1.2% + 3 digits) |
| | 40.00 VAC | |
| | 400.0 VAC | |
| | 600.0 VAC | |

All AC voltage ranges are specified for 5% of range to 100% of range.

AC voltage Bandwidth: 50 to 60Hz(All Wave); 50 to 1KHz(Sine Wave).

| | | |
|------------|-----------------|-------------------------|
| Resistance | 400.0 Ω | \pm (1.5% + 8 digits) |
| | 4.000K Ω | |
| | 40.00K Ω | |
| | 400.0K Ω | \pm (3.5% + 5 digits) |
| | 4.000M Ω | |
| | 40.00M Ω | |

| | | |
|-------------|---------------|--------------------------|
| Capacitance | 4.000nF | \pm (4.0% + 40 digits) |
| | 40.00nF | \pm (4.0% + 10 digits) |
| | 400.0nF | |
| | 4.000 μ F | \pm (4% + 5 digits) |
| | 40.00 μ F | |
| | 400.0 μ F | \pm (3.5% + 5 digits) |
| | 4.000mF | |

| Function | Range & Resolution | Accuracy \pm (% of reading) |
|---------------|--------------------|--------------------------------|
| Temp (Type-K) | -20.0 to 760.0°C | $\pm(1.5\% + 5^\circ\text{C})$ |
| | -4.0 to 1400.0°F | $\pm(1.5\% + 9^\circ\text{F})$ |

(Probe accuracy not included)

Function with Test Leads (AC Voltage)

| Function | Range | Accuracy \pm (% of reading) |
|--|---------------|---------------------------------|
| Frequency (Auto-Ranging) Sensitivity: >15V AC rms | 10Hz to 10KHz | $\pm(1.2\% + 5 \text{ digits})$ |

3-2.General Specifications

| | |
|------------------------|--|
| Clamp Size | Opening 1.18" (30mm) approx |
| Diode Test | Test current of 1mA typical; Open circuit voltage 2V DC typical. |
| Continuity Test | Audible signal if the resistance is <50 Ω |
| Low Battery Indication | "  " is displayed |
| Over Range Indication | "OL" is displayed |
| Polarity | Minus symbol "-" is displayed for negative polarity |
| Measurements Rate | 3 readings per second, nominal |
| Input Impedance | >10M Ω (VDC and VAC) |
| Display | 4000 counts LCD |
| AC Current | 50-60Hz (AAC) |
| AC Voltage Bandwidth | 50-1000Hz (VAC) |
| Operating Environment | 0 to 40°C (32 to 104°F) at 70% Relative Humidity |
| Storage Environment | -10 to 50°C (14 to 122°F) at 80% Relative Humidity |
| Operating Altitude | 2000meters |
| Safety | Category III 600V |
| Battery | Two "AAA" 1.5V Batteries |
| Auto Off | Approx. 15 minutes |

4.Operation

NOTICES: Read and understand all warning and precaution statements listed in the safety section of this operation manual prior to using this meter. Set the function select switch to the OFF position when the meter is not in use.

4-1.AC Current Measurements

WARNING: Ensure that the test leads are disconnected from the meter before making current clamp measurements.

- 1.Set the Function switch to the **40A** or **400A** range.
2. If the range of the measured is not known, select the higher range first then move to the lower range if necessary.
- 3.Press the trigger to open jaw. Fully enclose one conductor to be measured.
- 4.The clamp meter LCD will display the reading.

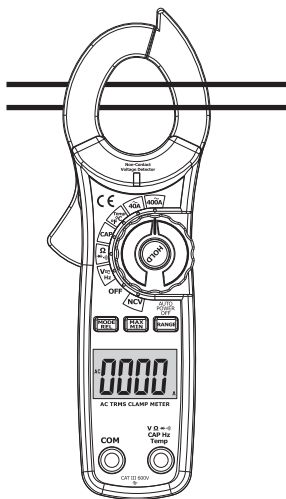

NO

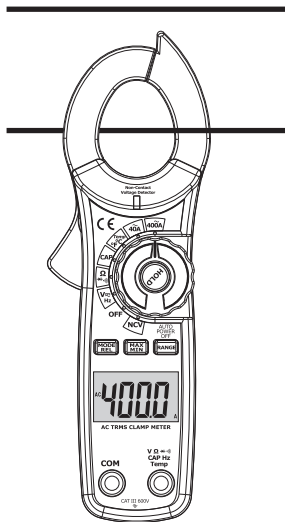

YES

4-2. DC/AC Voltage(Frequency) Measurements

WARNING: Observe all safety precautions when working on live voltages.

1. Insert the black test lead into the negative **COM** terminal and the red test lead into the positive **V** terminal.
2. Set the function switch to the **VDC/AC** position.
3. Select AC or DC with the **MODE** button.
4. Connect the test leads in parallel to the circuit under test.
5. Read the voltage measurement on the LCD display.
6. Press the button to indicate "**Hz**" MODE.
7. Read the frequency in the display.

4-3. Resistance Measurements

1. Insert the black test lead into the negative **COM** terminal and the red test lead into the positive terminal.
2. Set the function switch to the Ω \rightarrow \rightarrow \rightarrow position.
3. Press the **MODE** button until the " Ω " symbol appears on the LCD display.
4. Touch the test lead probes to the component under test. If the component is installed in a circuit, it is best to disconnect one side before testing to eliminate interference with other devices.
5. For Resistance tests, read the resistance on the LCD display.

4-4. Diode and Continuity Measurements

WARNING: Never test diodes in a live circuit.

1. Insert the black test lead banana plug into the negative **COM** jack and the red test lead banana plug into the positive diode jack.
2. Set the rotary switch to the Ω \rightarrow \rightarrow \rightarrow position.
3. Press the **MODE** button until " \rightarrow " appears in the display.
4. Touch the test lead probes to the diode under test.
5. Forward voltage will indicate 0.4V to 0.7V. Reverse voltage will indicate "OL". Shorted devices will indicate near 0mV and an open device will indicate "OL" in both polarities.
6. Press the **MODE** button until " \rightarrow " appears in the display.
7. For Continuity tests, a beeper will sound if the resistance is approx 50 ohms or less and the resistance reading will be shown on the LCD display.



4-5. Capacitance Measurements

WARNING: To avoid electric shock, disconnect power to the unit under test and discharge all capacitors before taking any capacitance measurements. Remove the batteries and unplug the line cords.

1. Set the rotary function switch to the **CAP** position.
2. Insert the black test lead banana plug into the negative **COM** jack. Insert the red test lead banana plug into the positive **V** jack.
3. Touch the test leads to the capacitor to be tested.
4. Read the capacitance value in the display

4-6. Temperature Measurements

WARNING: To avoid electric shock, disconnect both test probes from any source of voltage before making a temperature measurement.

1. Set the function switch to °C or °F.
2. Insert the Temperature Probe into the negative **COM** and the **V** jacks, making sure to observe the correct polarity.
3. Touch the Temperature Probe head to the part whose temperature you wish to measure. Keep the probe touching the part under test until the reading stabilizes (about 30 seconds).
4. Read the temperature in the display. The digital reading will indicate the proper decimal point and value.

WARNING: To avoid electric shock, be sure the thermocouple has been removed before changing to another measurement function.

4-7. Non-Contact AC Voltage Measurements

WARNING: Risk of Electrocution. Before use, always test the Voltage Detector on a known live circuit to verify proper operation.

1. Set the rotary function switch to the **NCV** position .
2. Hold the detector close to the AC voltage being tested.
3. If no signal is detected, the LCD will show "EF", NCV indicator light doesn't flashes and the buzzer is no sound. According to the detected signal strength, LCD displays different horizontal lines. When the signal is strongest, LCD displays three horizontal lines, when the signal is weakest, only one line. Meanwhile, NCV indicator light flashes, buzzer make different sound.

NOTE: The conductors in electrical cord sets are often twisted. For best results, rub the probe tip along a length of the cord to assure placing the tip in close proximity to the live conductor.

NOTE: The detector is designed with high sensitivity. Static electricity or other sources of energy may randomly trip the sensor. This is normal operation.

4-8.Auto Power Off

The auto off feature will turn the meter off after 15 minutes. To disable the auto power off feature, hold down the **MODE** button and turn the meter on.

4-9.Low Battery Indication

The “” icon will appear in the left corner of the display when the battery voltage becomes low. Replace the battery when this appears.

5.Button

5-1.MODE and REL Button

- Press the **MODE** key to select AC/DC Voltage, AC Current ,Ohms, Diode Test, Continuity or Capacitance and Temperature.
- The **RELATIVE** function zeros out the reading on the display and stores it as a reference. Subsequent readings will be displayed as the relative difference between the actual measurement and the stored reference value.To activate,press the **REL** button,The “**REL**” indicator will appear on the LCD display along with the relative reading. Press the **REL** button again to return to normal operation.

NOTE: REL does not work on Frequency,Diode Test, Continuity,NCV .

5-2.Data Hold Button

- To freeze the LCD meter reading, press the data hold button.
- The data hold button is located on the left side of the meter (top button).
- While data hold is active, the HOLD display icon appears on the LCD.
- Press the data hold button again to return to normal operation.

5-3.RANGE Button

When the meter is first turned on, it automatically goes into Auto Ranging. This automatically selects the best range for the measurements being made and is generally the best mode for most measurements. For measurement situations requiring that a range be manually selected, perform the following:

1. Press the **RANGE** button. The “Auto Range” display indicator will turn off, The “Manual Range” display indicator will turn on.
2. Press the **RANGE** button to step through the available ranges until you select the range you want.
3. Press and hold the **RANGE** button for 2 seconds to exit the Manual Ranging mode and return to Auto Ranging.

5-4. MAX/MIN Button

1. Momentarily press the button **MAX/MIN** to activate the MAX/MIN mode. The “MAX” indicator will appear on the LCD display. The meter will display and hold the maximum reading and will update when a higher “max” occurs.
2. Momentarily press the button again to view the lowest reading. The “MIN” indicator MAX/MIN meter will appear on the LCD display. The meter will display and hold the minimum reading and will update when a lower “min” occurs.
3. Press and hold the **MAX/MIN** button to end MAX/MIN and return to normal operation.

NOTE: The meter does not auto range when the MAX/MIN mode is active, the display will read “OL” if the range is exceeded. When this occurs, exit MIN/MIN and use the RANGE button to select a high range. MAX/MIN does not work on Frequency, Duty Cycle, Diode Test, Continuity and Capacitance.

6. Battery Replacement

1. Remove the one rear Phillips head screw.
2. Open the battery compartment.
3. Replace the Requires Two “AAA” 1.5V Battery(UM4 R03).
4. Re-assemble the meter.

